

Decora Smart with Z-Wave Technology



Z-Wave Plus Product Family

The Decora Smart with Z-Wave Plus Technology family of products feature five devices including in-wall dimmers, a switch, and plug-in modules for appliances and lamps. The family of solutions utilizes the latest generation of technology for advanced wireless lighting control products. As well, an in-wall outlet featuring Z-Wave technology is available for built-in control.

Most devices support a wide range of load types including LED, CFL, and incandescent amongst others at various wattages with multi-way capability for large rooms or hallways. The products are Z-Wave Plus certified, ensuring increased communication range, network wide inclusion, and over the air updates.

The highly advanced design features two-way feedback, is scene capable, and is supported by security systems, hubs, and gateways that are Z-Wave enabled which provide remote access and scheduling.

In-Wall Dimmers and switches boast the new Leviton design with true rocker action, pressing the top to turn on and the bottom to turn off. For the 600W and 1000W dimmers, the dim/brighten bar is conveniently located along the right hand side of the paddle, ensuring ease of use with the state-of-the-art device. Vanishing LEDs to the left of the Dimmer paddle show current and target light level with real-time feedback. To meet any decor, color change kits are available in white, ivory, light almond, gray, black, and brown. For the most professional and cleanest installation, pair the device with an optional Leviton screwless wallplate.



Features and Benefits

- Gloss finish complements any décor
- Compatible with Leviton vizia rf +
- Remotes available for 3-way/multi-location control
- Limited 5-year warranty

Z-WAVE PLUS CERTIFICATION

- Increased communication range
- Network Wide Inclusion
- Support for beaming and secure commands
- Over The Air (OTA) updates
- 500-Series Chipset

DZ1KD 1000W Dimmer with Z-Wave Technology

SINGLE POLE WIRING DIAGRAM

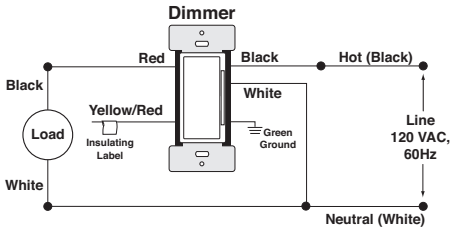

THREE-WAY WIRING DIAGRAM

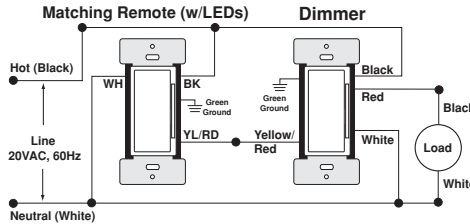

Agency Standing and Compliance

- Complies with UL 1472
- CSA Certified (File #003413)
- NOM-ANCE Certified
- Complies with FCC Part 15, Class B
- Z-Wave Plus Certified

DZ6HD 600W Dimmer with Z-Wave Technology

SINGLE POLE WIRING DIAGRAM

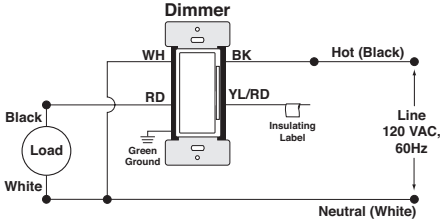

THREE-WAY WIRING DIAGRAM

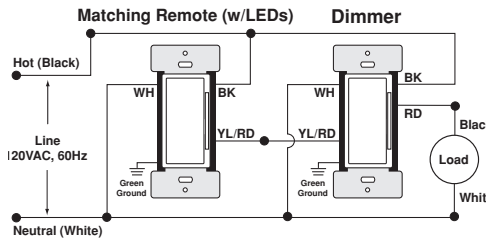

Agency Standing and Compliance

- Complies with UL 1472
- CSA Certified (File #003413)
- NOM-ANCE Certified
- Complies with FCC Part 15, Class B
- Z-Wave Plus Certified

DZ15S Switch with Z-Wave Technology

SINGLE POLE WIRING DIAGRAM

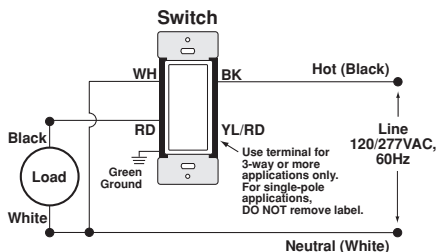

THREE-WAY WIRING DIAGRAM

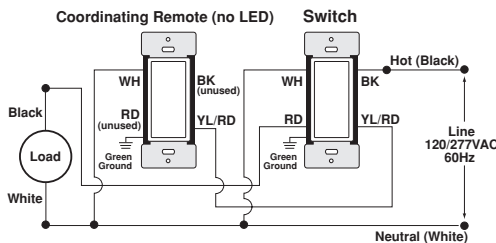

Agency Standing and Compliance

- Complies with UL 917
- CSA Certified (File #003413)
- NOM-ANCE Certified
- Complies with FCC Part 15, Class B
- Z-Wave Plus Certified

Dimensional Drawings

DZPA1 Plug-in Outlet with Z-Wave Technology

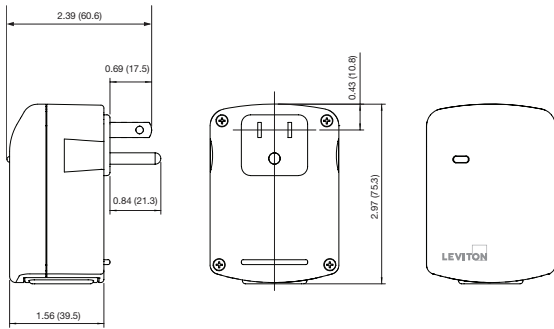

Agency Standing and Compliance

- Complies with UL 917
- CSA Certified (File #003413)
- NOM-ANCE Certified
- Z-Wave Plus Certified
- Complies with FCC Part 15, Class B

DZPD3 Plug-in Dimmer with Z-Wave Technology

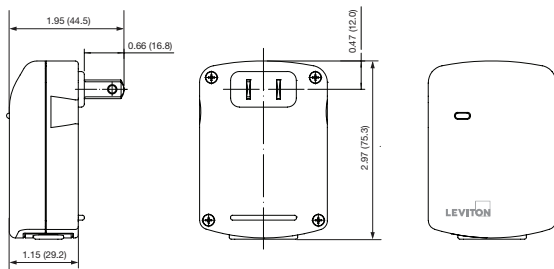

Agency Standing and Compliance

- Complies with UL 1472
- CSA Certified (File #003413)
- NOM-ANCE Certified
- Z-Wave Plus Certified
- Complies with FCC Part 15, Class B

Ordering Information

Description	Cat. No.
1000W Dimmer with Z-Wave Technology	DZ1KD-1BZ
600W Dimmer with Z-Wave Technology	DZ6HD-1BZ
15A Switch with Z-Wave Technology	DZ15S-1BZ
Plug-in Outlet with Z-Wave Technology	DZPA1-2BW
Plug-in Dimmer with Z-Wave Technology	DZPD3-2BW
Matching Dimmer (for Multi-Location)	DD00R-DLZ
Matching Switch (for Multi-Location)	DD0SR-DLZ

Leviton Manufacturing Co., Inc. Global Headquarters

201 North Service Road, Melville, NY 11747-3138
 Tel: 1-800-323-8920 Fax: 1-800-832-9538
 Tech Line: (8:30AM-7:00PM ET Monday-Friday): 1-800-824-3005

Leviton Manufacturing Co., Inc. Energy Management, Controls and Automation

865 Fulton St., Suite 500, New Orleans, Louisiana, 70130
 Tel: 1-504-608-9001

Visit our website at: leviton.com/emca

©2018 Leviton Manufacturing Co., Inc. All rights reserved.

